

Manual High-Pressure Cleaner HW 9120



Perfection is our aim

Wilms®

INDEX OPERATING MANUAL HW 9120

1. Preparation of the high-pressure cleaner	page	1
2. Description of the symbols	page	2
3. Introduction	page	3
4. Precautions	page	3
5. Intended use	page	4
6. Preparation	page	4 – 5
7. General warnings about installation and use	page	6
8. Operation of the high-pressure cleaner	page	7 – 8
9. Advise on using detergents	page	8
10. Maintenance	page	8 – 10
11. Trouble shooting	page	11
12. Technical specifications	page	12
13. Spare-Parts List	page	13 – 29

WILMS HW 9120

Congratulations! We wish to thank you

for buying this cleaner. You have shown that you do not accept compromises: *you want the best.*

We have prepared this manual to enable to fully appreciate the qualities and high performance that this cleaner can offer you. Please read it completely before using the machine.

The CE mark on your cleaner shows that it has been constructed in compliance with the European Standards on safety.

We can also offer you a wide range of cleaning machines such as:

VACUUM CLEANERS, SCRUBBER DRYERS, SWEEPERS and a complete range of **ACCESSORIES** and **DETERGENTS** suitable for cleaning all kinds of surfaces.

Ask your dealer for the complete catalogue of our products.

The manufacturer also reserves the right to alter and update this publication without prior notice for the sake of product improvement.

All reproductions of this manual, in whole or in part, are forbidden without the manufacturer's authorization.

1. PREPARATION OF THE HIGH-PRESSURE CLEANER

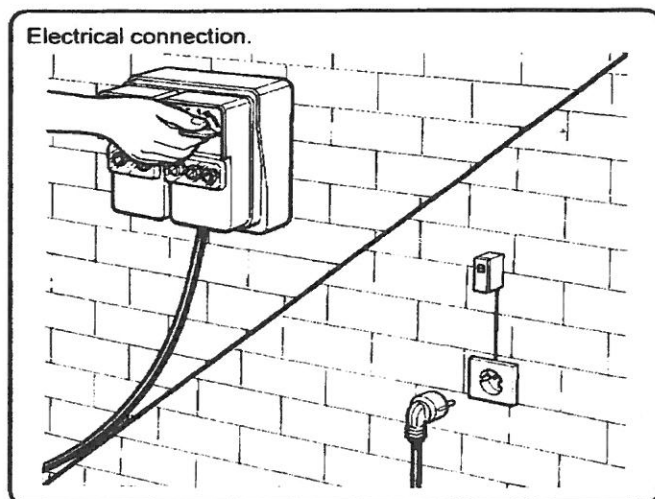
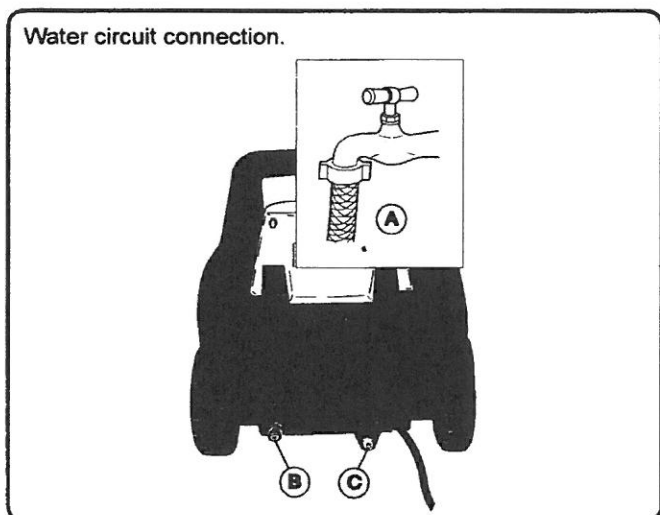
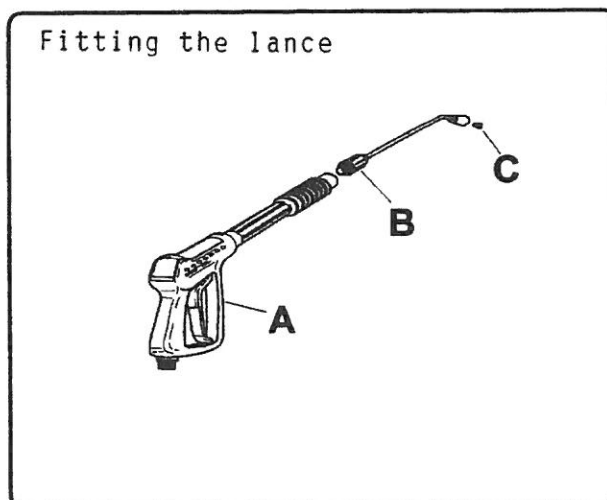

Continue reading this manual without connecting this cleaner to the power mains and the water supply.

WILMS HW 9120

2. DESCRIPTION OF THE SYMBOLS

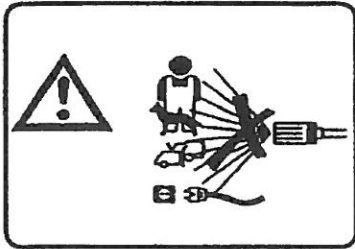

DO NOT DIRECT THE JET AGAINST PEOPLE, ANIMALS, POWER SOCKETS OR THE MACHINE ITSELF.

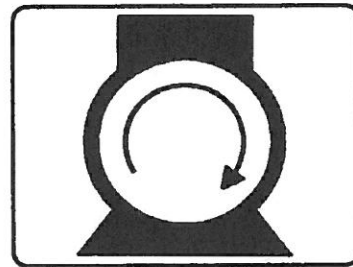

SWITCHING ON THE PUMP MOTOR

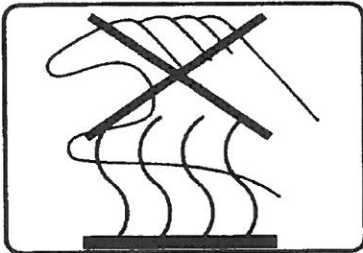

ATTENTION: RISK OF BURNS

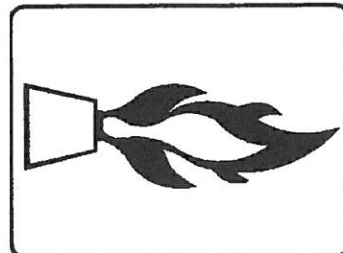

LIGHTING THE BURNER

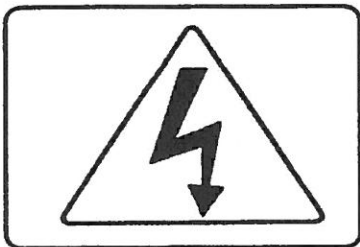

ATTENTION: RISK OF ELECTRIC SHOCK

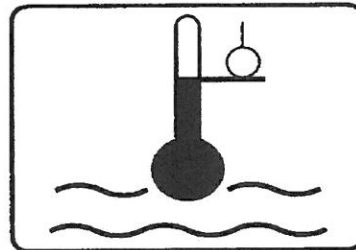

ADJUSTING THE WATER TEMPERATURE

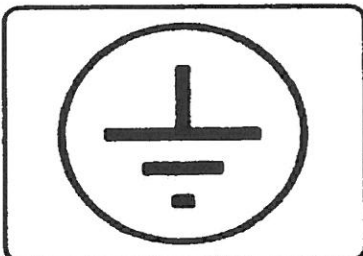

EARTH

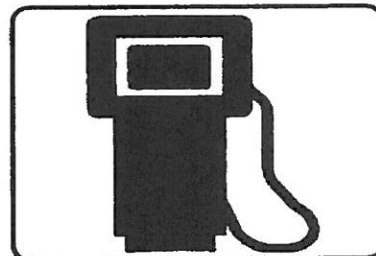

FUEL (HEATING OIL/ DIESEL)

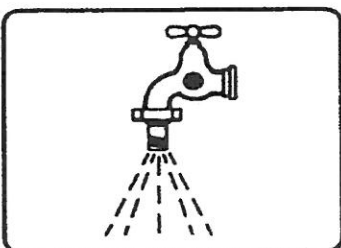

WATER INPUT

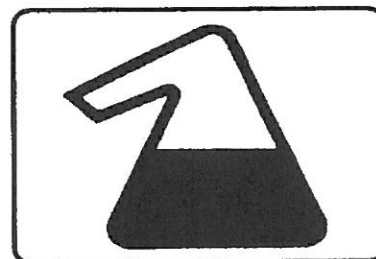

CHEMICALS (DETERGENT)

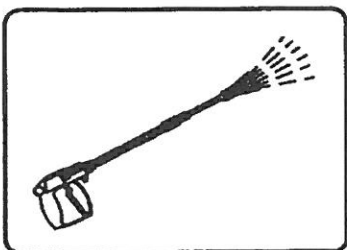

WATER OUTPUT

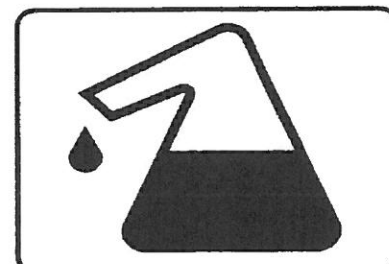

ANTI-SCALE PRODUCT

WILMS HW 9120

The most important instructions are marked with the symbol:



3. INTRODUCTION



This manual must be read before installing, setting up and using the cleaner.

The manual is an integral part of the product.

Read the warnings and instructions in this manual carefully as they provide important indications as to **SAFETY in USE and MAINTENANCE**, paying special attention to the general rules for safety.

KEEP THIS MANUAL CAREFULLY FOR FUTURE CONSULTATION!



The contents of this manual must be brought to the attention of persons using this high-pressure cleaner and the staff responsible for maintenance.

4. PRECAUTIONS

The user must observe the conditions for use of the appliance prescribed by the rules, and particularly he must respect the following classification:

As for the protection against electric shock, the high pressure cleaner belongs to **CLASS 1**.

The high pressure cleaner is factory set and all its safety devices are sealed. **It is forbidden to alter their adjustment values.**

In the hot water cleaner the water is heated by a burner fed with **Diesel fuel**.

The high pressure cleaner must be always used on a firm and flat ground, furthermore it must not be moved while it is working or connected to the electric supply.

Failure to observe this prescription may cause danger for the user.

The high pressure cleaner must not be used in the presence of corrosive or potentially explosive atmospheres (vapours or gas).

The electric connection must be performed by qualified technicians who are able to work in observance of the governing rules and of the manufacturer's instructions.

A wrong electric connection may cause damage to persons, animals or things, and the manufacturer cannot be considered responsible for these.

The high pressure cleaners are equipped with a plug for connection to the electric supply.

In this case please check if the electric power system and the electric sockets are compatible with the max. power of the appliance indicated on the plate (kW). indicated on the plate (kW).

In case of doubt, please apply to qualified personnel. If the socket and the plug of the machine are not compatible, have the plug replaced with a suitable type by qualified personnel.

Before connecting the machine make sure that the data indicated on the plate correspond to those of the electric supply.

The electric safety of this machine may be assured only when it is properly connected to an efficient grounding system in accordance with the governing laws for electric safety.

It is necessary to check this essential safety requisite. In case of doubt, ask for accurate control of the power system by qualified personnel.

The manufacturer may not be considered responsible for damages occurred because of the lack of the grounding system.

Failure to respect the above absolves the manufacturer of all liability and represents negligent use of the product.



High pressure cleaners with the „Total Stop“ device should be considered as off when the omnipolar switch is in the „0“ position or the plug is unplugged from the socket.

WILMS HW 9120

5. INTENDED USE

This appliance is intended exclusively for cleaning machines, vehicles, buildings and general surfaces suitable for treatment with a high pressure jet of detergent solution between 40 and 100 bar.

This appliance has been designed for use with the detergents supplied or recommended by the manufacturer. The use of other detergents or chemicals may influence the safety of the appliance.

This appliance must be used only for the purpose for which it was specifically designed.

All other uses are to be considered incorrect and therefore unreasonable.

Examples of unreasonable use:

- Washing surfaces not suitable for cleaning with a high pressure jet.
- Washing people, animals, electric equipment of the machine itself.
- Using unsuitable detergents or chemicals.
- Blocking the trigger (lever) of the lance in delivery position.

The manufacturer cannot be held responsible for any damage due to improper, incorrect or unreasonable use. As far as safety rules are concerned, the cleaners are manufactured according to the European Standard 60 335-1 (General standard) and EN 600335 2 79 (Specific standard).

6. PREPARATION

UNPACKING

After unpacking, ensure that the cleaner is undamaged. If in doubt, do not use the machine. Contact your dealer.

Packaging (bags, boxes, nails, etc.) is potentially dangerous and should be kept out of reach of children. It should be disposed off or retained in respect of national environmental legislation.

FITTING THE SEPARATE PARTS OF THE MACHINE

All the fundamental parts and safety devices of the machine are assembled by the manufacturer.

For reasons of packing and transport, some secondary cleaner parts are supplied separately.

The user must fit these parts as explained in the instructions supplied in each assembly kit.

DATA PLATE:

The data plate bearing the main technical characteristics of your cleaner is located on the trolley and is always visible.



When buying your cleaner, ensure that it has an identification plate. If there is no plate, inform the manufacturer and/or the dealer immediately. Machines without a plate must not be used and the manufacturer declines all responsibility for them. Products without a plate must be considered anonymous and potentially dangerous.

FILLING THE FUEL TANK

Fill the tank with fuel for Diesel motors (fig. 1)



Do not use different fuel from that indicated on the identification plate. Check the fuel from time to time while the cleaner is operating. Attempting to use the cleaner without fuel may cause damage to the fuel pump.

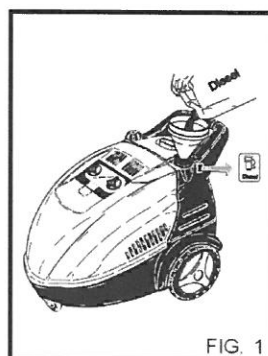

FIG. 1

FILLING THE DETERGENT TANK

From the range of recommended products, choose the one most suited to the washing job to be done (fig. 2) and dilute it with water according to the instructions on the pack. Fill the detergent tank with the diluted product (fig. 3).

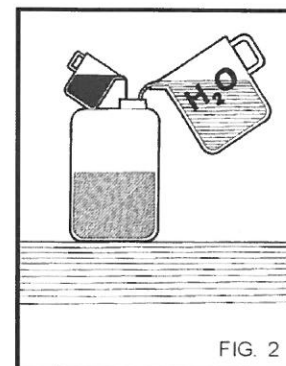

FIG. 2

Ask your dealer for the catalogue of the detergents that can be used depending on the type of washing job to be done and the type of surface to be treated.
After using the detergent, the detergent intake circuit must be flushed out with clean water.

FILLING THE WATER SOFTENER TANK

Fill the tank with water softener solution. Use only products recommended by the manufacturer and/or dealer. Follow the instructions given on the packaging meticulously.

WATER CIRCUIT CONNECTION

Connect the feed hose to the mains (Fig.5A) and to the hosedtail on the cleaner (Fig.5B).

Check that the pressure and quantity of the water supplied by the mains are sufficient for the cleaner to work properly: (2 to 4 bar).

Maximum temperature of feeding water 50 ° C (122° F).

Connect the high pressure hose to the cleaner (Fig.5C) and to the lance (Fig.6).

IMPORTANT:

The cleaner must operate with clean water. Dirty or sandy water, corrosive chemicals and solvents can cause severe damage to the cleaner.

Failure to respect the above absolves the manufacturer of all liability and represents negligent use of the product.

ELECTRICAL CONNECTION

Connection of the cleaner to the mains must be carried out by skilled technicians able to ensure that all regulations in force are complied with use in respect of current standards and legislation.

Ensure that the mains voltage available is the same as the voltage at which the cleaner is supposed to work (this is indicated on the identification plate).



The electric cable must be protected from accidental crushing.



Do not use the machine if the supply cable is damaged.



The use of any electric appliance requires the respect of some basic rules:

- Do not touch the appliance with wet or damp hands or feet.
- Do not use the appliance bare-footed or with unsuitable clothing.
- Do not pull the supply cable or the appliance itself in order to disconnect the plug from the electric supply.

As for the protection against electric shock, the high pressure cleaner belongs to **CLASS I**.



Failure to observe the above warning frees the manufacturer from all responsibility and constitutes negligent use of the product.

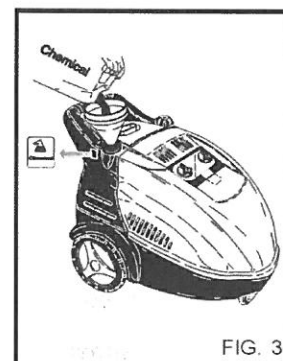

FIG. 3

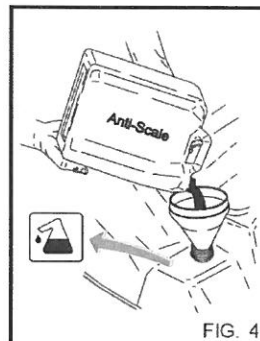

FIG. 4

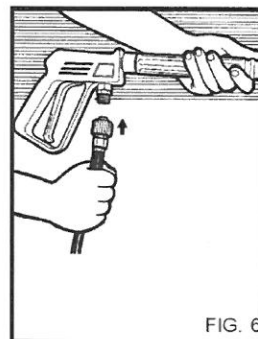

FIG. 6

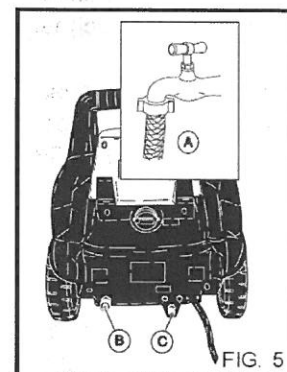
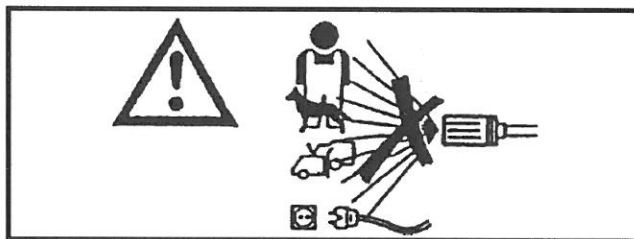

FIG. 5

7. GENERAL WARNINGS ABOUT INSTALLATION AND USE

- ⚠ The use of any electric appliance requires the respect of some basic rules:
 - Do not touch the appliance with wet or damp hands or feet.
 - Do not use the appliance bare-footed or with unsuitable clothing.
 - Do not pull the supply cable or the appliance itself in order to disconnect the plug from the electric supply.
- ⚠ The H.P. cleaner must not be used by children, teen-agers or incapable persons (under the influence of alcohol, etc.)
- ⚠ Use only original accessories that can allow safe working of the appliance.
- ⚠ The flexible hose connecting the lance to the H.P. cleaner must not be damaged. In case of damage, replace it immediately.
- ⚠ Hoses, connections and fittings for high pressure systems are very important to guarantee the safety of the H.P. cleaner. Use only original spare parts which have the manufacturer's approval.
- ⚠ Do not use the H.P. cleaner when persons or animals are in its action field.
- ⚠ High pressure jets may be dangerous if not properly used. The jet must never be directed at persons or animals, electric appliances or at the appliance itself.
- ⚠ The high pressure water jet causes a reaction power on the lance. Hold the lance grip vigorously.
- ⚠ The use of the H.P. cleaner must be considered according to the kind of washing which must be performed. Protect yourself against the ejection of solid materials or corrosive substances by means of adequate protective clothing.



- ⚠ The use of the H.P. cleaner must be considered according to the place where the washing is performed (for example: food plants, pharmaceutical plants, etc.) Pertinent rules and safety conditions must be followed.
As for the protection against electric shock, the H.P. cleaner belongs to **CLASS I**.
- ⚠ Do not direct the water jets at your own or other people's body in order to clean clothes or shoes.
- ⚠ While working it is forbidden, to block the trigger (lever) of the lance in delivery position.
- ⚠ In the hot water H.P. cleaners a Diesel fuel burner is used for water heating. The use of other fuels is dangerous.
- ⚠ Before starting any cleaning or maintenance operation, disconnect the machine from the electric and water supply networks.
- ⚠ Periodically, at least once a year, have the safety devices checked by one of our service centres.
- ⚠ If the appliance is to be used in an enclosed space, install an exhaust fume extraction system and guarantee adequate ventilation.
- ⚠ Do not use the machine if the supply cable is damaged.
- ⚠ For the replacement of the damaged cable apply exclusively to one of our technical service centres.
- ⚠ In case of damage or malfunction, switch off the appliance (disconnecting it from the water main and from the electricity main via the omnipolar switch).
- ⚠ The electric power cable must never be under mechanical tension and must be protected against accidental crushing.

8. OPERATION OF THE HIGH-PRESSURE CLEANER

CONTROL PANEL

- A – On/Off switch
- B – Temperature regulator
- C – Detergent control tap

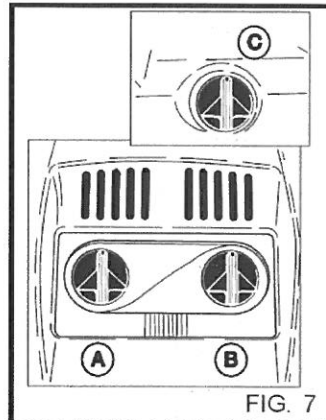

STARTING THE CLEANER

- 1) Turn on the water supply tap (fig. 5A).
- 2) Connect the water cleaner to the mains electricity supply via the omnipolar switch or by plugging the plug into the socket.
- 3) Start the cleaner by turning the selector switch to pos. 1 (fig. 7A).
The high pressure water jet generates a reaction force in the lance. Keep a firm grip on the lance handle.
- 4) Press the trigger on the gun and begin washing.
- 5) To use the cleaner with hot water, turn the temperature regulator (fig. 7B) to the recommended washing values.

 In water cleaners with the „Total Stop“ system, the motor starts and stops when the lever on the lance handle is pulled or released.

 Do not block the handle lever in the delivery position.

IMPORTANT!

To eliminate any impurities or air bubbles from the water circuit we advise starting the cleaner for the first time without the lance and letting the water run out for a few seconds.

Impurities could block the nozzle and cause malfunction (fig. 8).

STOPPING THE CLEANER

- 1) Switch off the burner by turning the thermostat regulator to pos. „0“ (fig. 7B).
- 2) Let the cleaner run with cold water only for at least 30 seconds to cool down the boiler.
- 3) Stop the cleaner by turning the selector switch to pos. „0“ (fig. 7A).
- 4) Discharge the pressure from the H.P.hose by pressing the trigger on the gun.
- 5) Disconnect the water cleaner from the mains electricity supply via the omnipolar switch or by unplugging the plug from the socket.
- 6) Turn off the water supply tap (fig. 5A).

 If the water cleaner is left, even temporarily, turn it off by using the omnipolar switch or by unplugging the plug from the socket.

 Water cleaners with the „Total Stop“ device should be considered as off when the omnipolar switch is in „0“ position or the plug is unplugged from the socket.

 When the water cleaner is not used, close the safety device on the handle (fig. 10).

 Dry use of the water cleaner causes serious damage to pump gaskets.

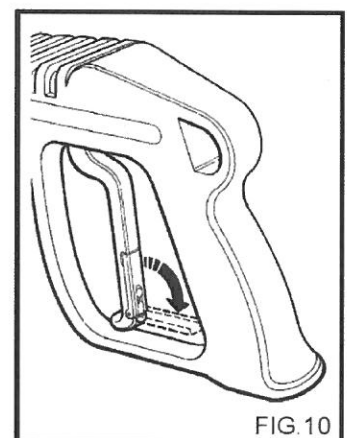
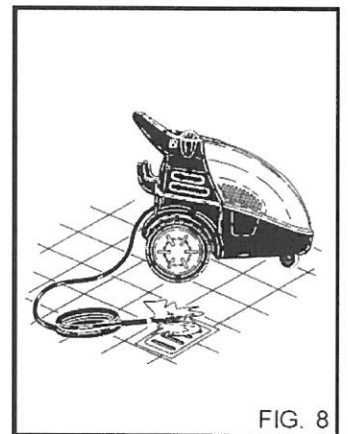

WILMS HW 9120

REGULATING PRESSURE AND USING STEAM

The pressure regulator (fig. 12), allows the operator to adjust the working pressure. When knob C is turned in an anti-clockwise direction (B) (minimum), the working pressure is reduced.

Turn the thermostat knob „B“ (fig. 7) to steam position to obtain an increase in the temperature of the water at delivery.

At work temperatures then are higher than 95°C (203°F).



During use with boiling water, „Steam Phase“, keep away from the openings for fumes discharge (risk of burning).
When you have finished using the „Steam Phase“, turn the thermostat knob „B“ to position „0“ (fig. 7) and let the machine cool down for about 3 minutes with the gun turned on.

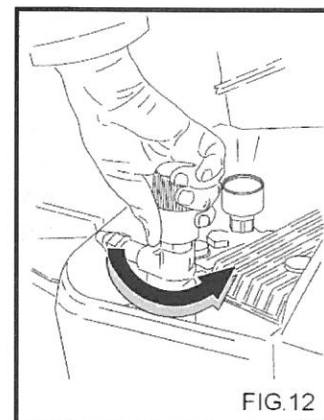

FIG.12

9. ADVICE ON USING DETERGENTS

This cleaner has been designed for use with the detergents supplied or recommended by the manufacturer. The use of other detergents or chemicals may influence the safety of the cleaner.

- 1) For environmental compatibility, we recommend a reasonable use of detergents, according to the instructions on the pack.
- 2) From the range of recommended products, choose the one most suited to the cleaning job to be done and dilute it with water according to the instructions on the pack or in the catalogue of the detergents most suited for the type of hot or cold water cleaner.
- 3) Ask for our detergent catalogue.

OPERATING PHASES FOR CORRECT CLEANING WITH DETERGENTS.

- 1) Prepare the solution of detergent at the concentration most suitable for the type of dirt and the surface that is to be washed.
- 2) Start the cleaner, turn on the detergent tap, and spray the dirty surface with the diluted product, working from bottom to top. Let it react for a few minutes.
- 3) Rinse the whole surface well from top to bottom with hot or cold water at high pressure.
- 4) After use with detergent, rinse the high pressure water circuit by operating the pump for one minute with the detergent tap completely closed.

10. MAINTENANCE

**ONLY THE OPERATIONS AUTHORIZED IN THIS INSTRUCTIONS MANUAL MAY BE CARRIED OUT BY THE USER.
ALL OTHER OPERATIONS ARE FORBIDDEN.**



For maintenance of the boiler, high pressure pump, the electrical parts and all parts with a safety function, please apply to our technical service centre.



Disconnect the water cleaner from the mains electricity supply via the omnipolar switch or by unplugging the plug from the socket and close the water supply tap (see chapters on connecting to the electricity and water mains) before carrying out any maintenance jobs. Once maintenance has been completed, ensure that the closing panels have been correctly reassembled and anchored with the screws provided before reconnecting the cleaner to the mains.

Failure to do so may cause a risk of electric shock!

PRECAUTIONS AGAINST FROST

The cleaner must not be exposed to frost.

If the cleaner is left in premises where it is exposed to frost, when work is over or for storage, antifreeze must be used to prevent serious damage to the hydraulic circuit.

WILMS HW 9120

OPERATIONS FOR USING ANTIFREEZE

- 1) Turn off the water supply (tap), disconnect the hose and run the cleaner until it is completely empty.
- 2) Stop the water cleaner with the ON/OFF switch in the „O“ position.
- 3) Fill the water tank with antifreeze solution.
- 4) Start the water cleaner with the ON/OFF switch in the „I“ position.
- 5) Start the cleaner and let it run until antifreeze comes out through the lance.
- 6) Suck up antifreeze with the detergent intake system too.
- 7) Disconnect the water cleaner from the mains electricity supply via the omnipolar switch or by unplugging the plug from the socket.

CHECKING PUMP OIL LEVEL AND OIL CHANGE

From time to time check the oil level in the high pressure pump by means of the sight glass (fig. 14A) or the dipstick (fig. 14B).

If the oil has a milky appearance, call the technical service centre immediately.

Change the oil after the first 50 hours' work and subsequently every 500 hours or once a year.

Proceed as follows:

- 1) Unscrew the drain cap situated under the pump (fig. 14C).
- 2) Unscrew the cap with the dipstick (fig. 14).
- 3) Let all the oil drain off into a container and deliver it to an authorized oil collection and disposal centre.
- 4) Replace the drain screw and pour fresh oil in through the filling cap on top (fig. 15A) until it reaches the level indicated on the sight glass (fig. 15B).

Use only SAE 15 W/40 oil!

CLEANING THE FUEL FILTER AND TANK.

Remove and replace the inline fuel filter (fig. 16). Change it from time to time.

Empty the fuel tank.

Open the drain cap (fig. 17) and let any impurities drain out into a container. Flush out the tank with clean fuel and close the drain cap.

CLEANING THE WATER FILTER.

Clean the water intake filter regularly and free it from any impurities (fig. 18).



CHANGING THE NOZZLE

The high pressure nozzle fitted on the lance must be changed from time to time, as this component is subject to normal wear during use. Wear may generally be detected by a drop in the working pressure of the high-pressure-cleaner. To replace it, consult your supplier for instructions.

DESCALING

Descaling must be carried out from time to time because the scale present in the water partially desposits inside the hydraulic circuit and the coil which with time becomes clogged.

Apply to our technical service centre to have the machine descaled from time to time; this will save you money and increase the efficiency of the cleaner.

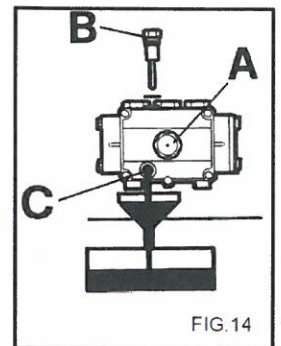

FIG. 14

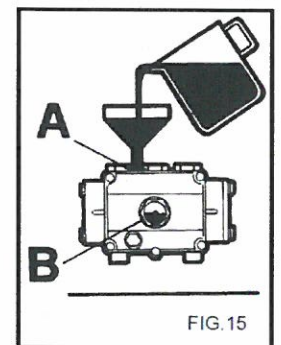

FIG. 15

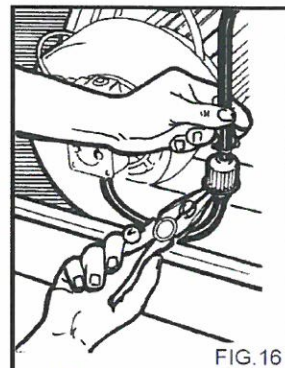

FIG. 16

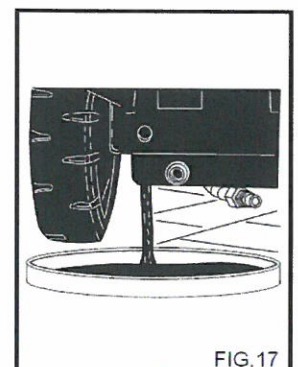

FIG. 17

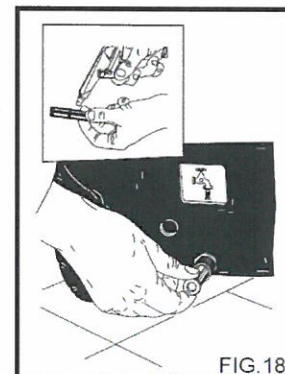

FIG. 18

WILMS HW 9120

TABLE OF ROUTINE MAINTENANCE TO BE PERFORMED BY THE USER

Description of operations:

Check power cable, pipes, high pressure connectors	Each use
1. oil change in H.P.pump	After 50 hours
Subsequent changes in H.P.pump	Every 500 hours
Change and clean fuel filters	Every 100 hours
Clean fuel tank	Every 100 hours
Clean water tank	Every 50 hours

TABLE OF EXTRAORDINARY MAINTENANCE TO BE PERFORMED BY THE TECHNICAL SERVICE CENTRE

Description of operations:

Boiler:

Clean coil	Every 200 hours
Descale coil	Every 300 hours
Clean fuel pump	Every 200 hours
Change fuel nozzle	Every 200 hours
Regulate electrodes	Every 200 hours
Change electrodes	Every 500 hours
Change seals on H.P.pump	Every 500 hours
Change lance nozzle	Every 200 hours
Calibrate and check the safety devices	Once a year

IMPORTANT:

These intervals refer to normal working conditions. For heavy duty use decrease the interval for each job.

For maintenance and/or repairs, use only original spare parts which offer the greatest characteristics of quality and reliability. Failure to use original spare parts absolves the manufacturer from all liability and transfers it to the person carrying out the operation.

WILMS HW 9120

11. TROUBLE SHOOTING



Before carrying out any operations, disconnect the water cleaner from the mains electricity supply via the omnipolar switch or by unplugging the plug from the socket!

FAULTS	CAUSES	REMEDIES
When the ON-OFF switch is turned the cleaner does not start.	Faulty electric connection. Thermal protection has tripped.	Check the mains voltage. Reset (if it trips again, apply to the technical service centre).
No jet or leakage from high pressure water circuit. After 30 seconds, the water cleaner stops.	Water supply filter clogged. Water nozzle clogged.	Clean. Clean.
	Mains water supply tap closed. Leakage from high pressure circuit.	Open. Contact Service Centre.
The pump functions but does not reach rated pressure.	Water supply filter clogged.	Clean.
	Pressure regulation valve is not set at maximum. Valves dirty or worn.	Regulate it. Contact Service Centre.
	Detergent tap open.	Close.
When the lance is open, the pressure drops and rises.	Nozzle clogged or deformed.	Clean or contact Service Centre.
	Inadequate water supply. Detergent tap open.	Check. Close.
In by-pass or total stop phase, the high pressure cleaner shuts down.	Micro-leaks of water from the high pressure circuit.	Contact Service Centre.
When the temperature regulator is brought to the required position, the burner does not start.	No diesel.	Check the level of diesel in the tank and make sure the fuel supply circuit is free of water.
Excessive smoke coming out of chimney.	Incorrect combustion.	Clean or replace diesel filters. Contact Service Centre.
	Fuel contaminated with impurities or water.	Empty the tank and clean thoroughly.
Insufficient detergent suction.	Detergent tap closed.	Open.
	No detergent.	Fill the detergent tank.
	Element or tube clogged.	Contact Service Centre.
Water leakage from pump head.	Gaskets worn.	Contact Service Centre.
Water in the oil.	Excessive humidity in atmosphere.	Replace oil.

IMPORTANT:

For maintenance and/or repairs, use only original spare parts which offer the greatest characteristics of quality and reliability. Failure to use original spare parts absolves the manufacturer from all liability and transfers it to the person carrying out the operation.

WILMS HW 9120

12. TECHNICAL SPECIFICATIONS

Type:	HW 9120
Max. water volume:	10 l/min.
Max. operating pressure:	150 bar
Working pressure:	40-100 bar
Working temperature:	30-120 °C
Voltage:	230 V / 50 Hz – single-phase
Rated current:	11,8 A
Fuse:	16 A
Water-Pump:	3-piston high-pressure pump with oil lubrication
Motor with overheat protection:	230 V – 50 Hz – 2,7 kW – single-phase
Oil burner:	robust – widely maintenance-free
Burner nozzle:	0,75 G 45°A – 13,5 bar
High-Pressure hose:	10 m
Permitted water nozzles:	1/4" 25045
Measurements: L X W X H	980 x 670 x 810 mm
Weight:	88 kg
Noise level: according to EN ISO 3744:2010	dB (A) 77

WILMS HW 9120

Spare-Parts List according to drawing 1

<u>Pos.</u>	<u>Order-No.</u>	<u>DESCRIPTION</u>	<u>Qty.</u>
1	3310294	Chassis	1
2	3310001	Wheel	2
3	3308208	Clamping for Wheel	2
4	3310002	Wheel Cap	2
5	3310003	Swivel Wheel	1
6	3310004	Cover Front	1
7	3310005	Flap	1
8	3310006	Detergent Tank	1
9	3310007	Fuel Tank	1
10	3308113	Drain Plug	2
11	3308112	Gasket for Drain Plug	2
12	3310008	Tank Cap	2
12a	3310020	Gasket	2
13	3310009	Handle	1
14	3310010	Handle	1
15	3310012	Back Wall	1
16	3310011	Back Wall	1
18	3310014	Bracket	1
19	1138905	Clamp	1
21	3309014	Control Box Bottom	1
22	5913044	Gasket	1,05 m
23	3310016	Gasket	1
24	3310295	Bracket	1
25	3309018	Cable Clamp	1
26	3300116	O-Ring	1
27	3309402	Bushing	1
28	3309016	Knob	2
29	3309209	Gasket	1
30	3309206	Coupling	1
31	3310042	Cover	1
32	3310019	Cover – White	1
33	6557611	High-Pressure Hose	1
34	1136232	Lance – Backpart	1
35	3308218	Lance – Frontpart 700 mm	1
36	3307129	Nozzle – 1/4" - 25045	1
38	3310100	Water Tank Kit	1
39	3309009	Nut	1
40	3310296	Cover	1
41	3310024	Bracket	2
45	3310077	Sticker	1
46	3309121	Plate	1
51	3310297	Metal Sheet	1
52	3310298	Bracket	2
53	3310230	Safety Bracket	1

For repairs use only original spare parts from the manufacturer!

WILMS HW 9120

Exploded view drawing picture 1

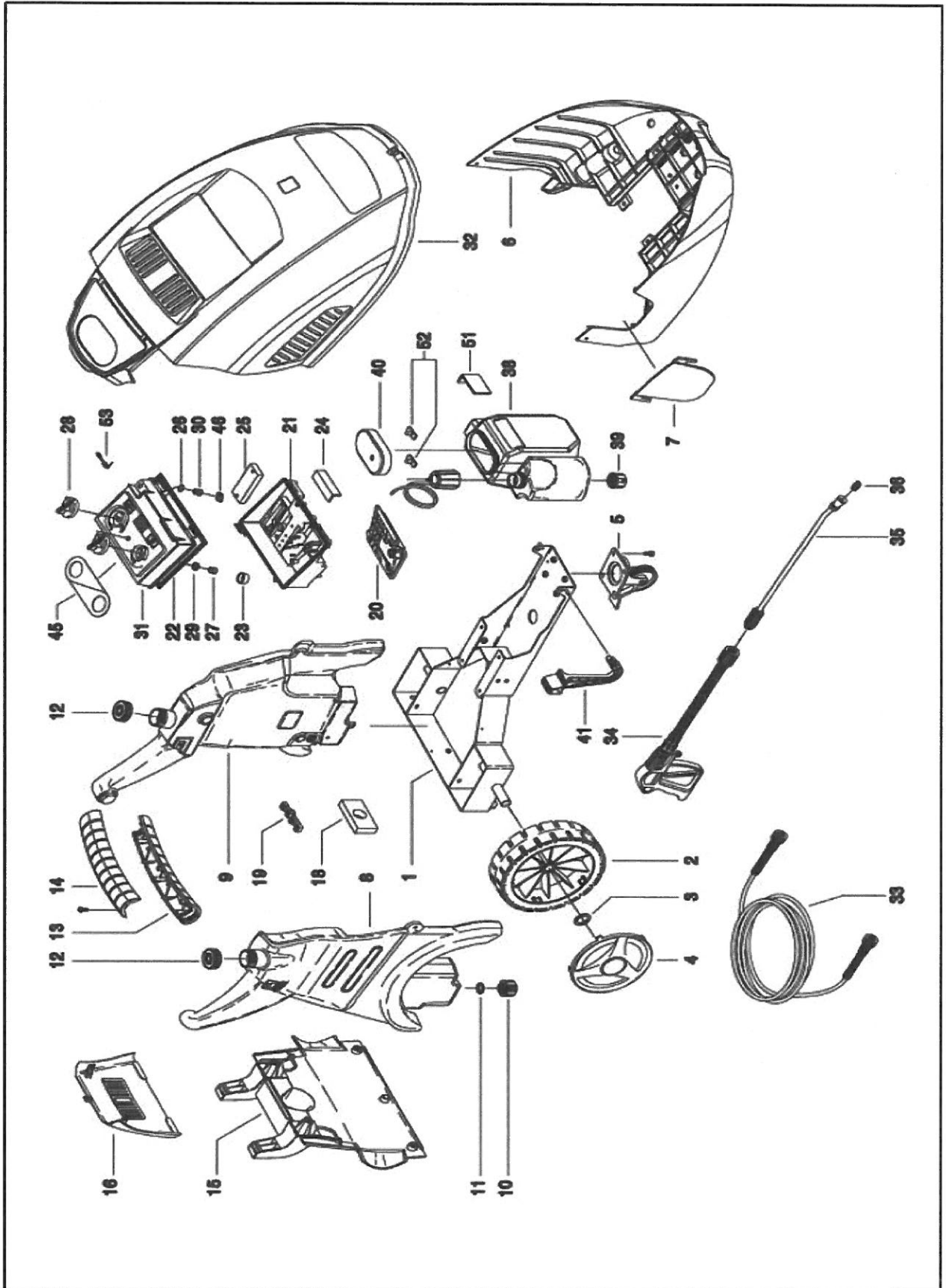

WILMS HW 9120

Spare-Parts List according to drawing 2

<u>Pos.</u>	<u>Order-No.</u>	<u>DESCRIPTION</u>	<u>Qty.</u>
1	1139025	Hose Connection	1
2	1139024	Plug Connection	1
3	1139022	RED-Piece	1
4	1139021	Gasket	1
5	3309621	Water Filter	1
6	3310030	Nut	1
7	3307106	Copper Washer 1/2"	1
8	3310032	Hose	1
9	3310033	Floater Complete	1
10	3309732	Hose	1
11	3309749	Suction Pipe	1
12	3310108	Clamp	1
13	3311080	Hose	1
14	3309131	Clamp	1
15	3310034	Hose	1
16	3310035	Nipple	1
17	3309731	Connecting Piece	1
18	3310036	Pump	1
19	3310301	Motor	1
20	3309415	Lock Nut	1
21	3309416	Nut	1
22	3309417	Hand Wheel	1
23	1138960	O-Ring	1
24	3310111	Cap	1
25	1138916	Pressure Gauge	1
26	3310305	Connector	1
27	3309219	Nipple	2
28	1138724	Hose 0,85 m	1
28a	1138724	Hose 0,50 m	1
29	3310041	Clamp	2
30-35	3307107	Metering Valve Complete	1
30	3309135	Body	1
31	3309266	O-Ring	1
32	3310136	O-Ring	1
33	3309137	Adjuster	1
34	3309138	Gasket	1
35	3309718	Spring	1
36	3310043	T-Piece	1
37	3310044	HP-Hose	1
38	3310045	Valve	1
39	3310046	Connector	1
40	3310047	Nut	1
41	3310048	Block	1
42	3309634	Nipple	1
43	3308193	Thermostat Sender Pocket	1
44	3308192	Spring	1
45	3310049	Connector	1
46	3309405	Valve	1
47	3308075	Oil-Hose	0,3 m
48	3309134	Clamp	1
49	3310234	Gasket	1
50	3309748	Pump	1
51	3310306	Cover	1
52	3310031	Nut	1

For repairs use only original spare parts from the manufacturer!

WILMS HW 9120

Exploded view drawing picture 2

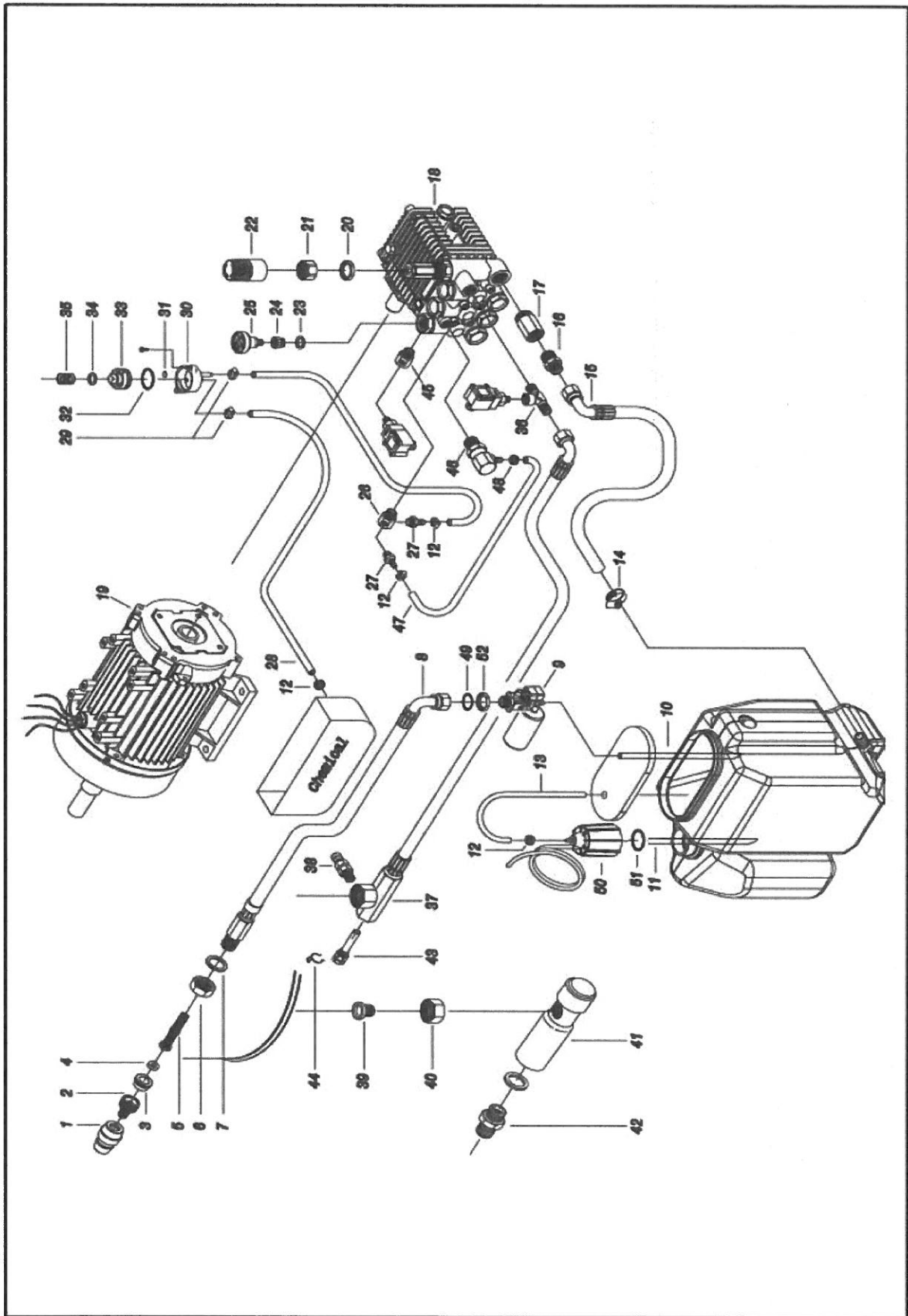

WILMS HW 9120

Spare-Parts List according to drawing 3

<u>Pos.</u>	<u>Order-No.</u>	<u>DESCRIPTION</u>	<u>Qty.</u>
1	3309073	O-Ring	2
2	3309072	Support-Ring	2
3	3309071	Ring Nut	2
4	3309070	Clamp	1
5	5914199	Split Pin	1
7	3309148	Boiler Lid – Bottom	1
8	3309146	Boiler Bottom	1
9	3310051	Bottom	1
11	3310052	Coil	1
12	3309643	Cover for Combustion Chamber	1
13	3310307	Outer Case	1
14	3309645	Gasket	1
15	3309065	Burner Cone	1
16	3309420	Baffle Plate	1
17	3309640	Nozzle	1
18	3310053	Electrode Holder	1
19	3308039	Elbow	1
20	3309060	Electrode	2
21	3309061	Electrode Holder	1
22	3310116	Fuel Line	1
22a	6160193	Nut	2
22b	6160192	Cutting Ring	2
23	3309144	Cable	1
24	3309753	Ignition Cable	2
25	3310055	Chimney Connector	1
26	3310308	Connector	1
27	3309059	Washer	2

For repairs use only original spare parts from the manufacturer!

WILMS HW 9120

Exploded view drawing picture 3

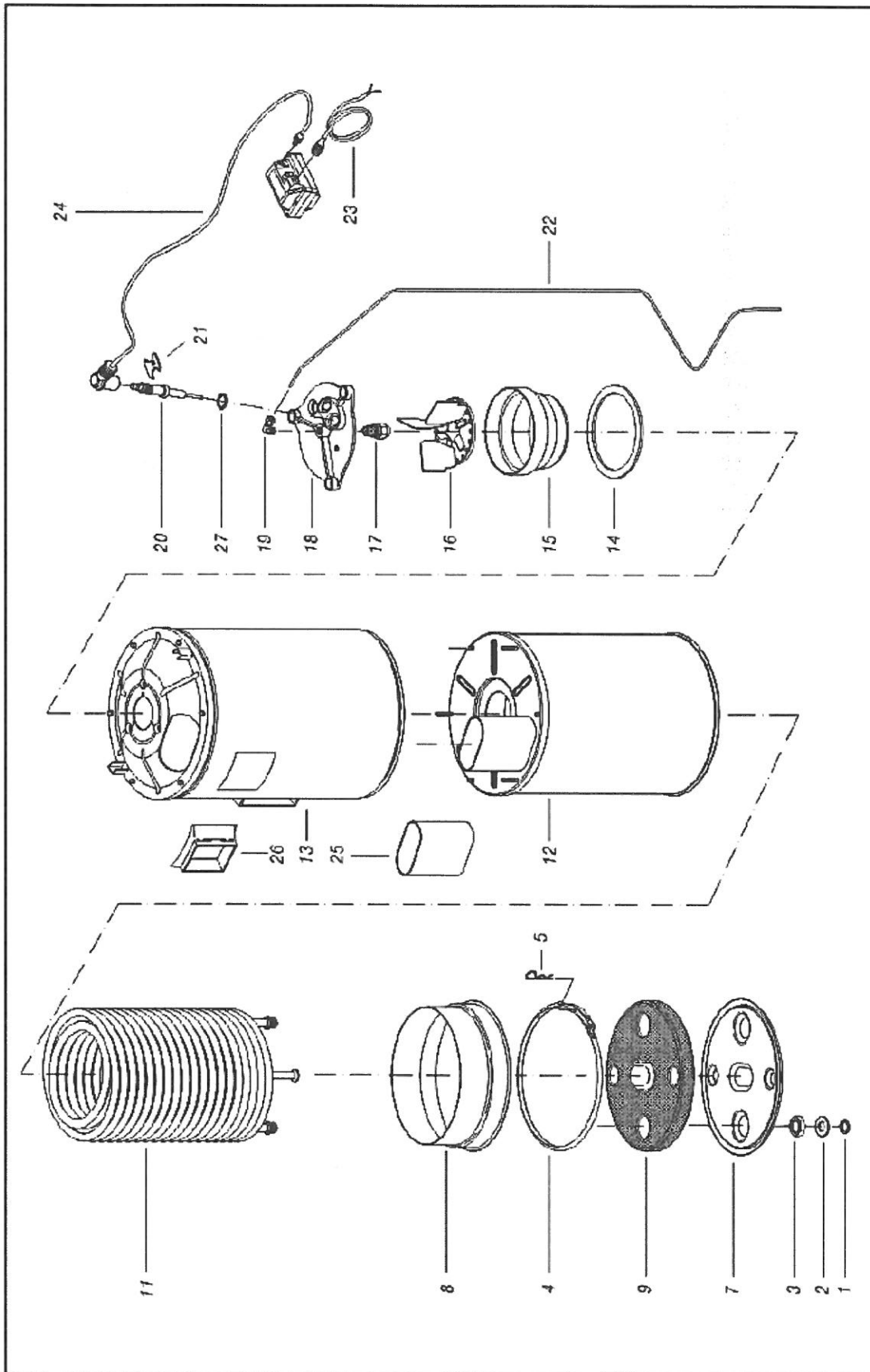

WILMS HW 9120

Spare-Parts List according to drawing 4

<u>Pos.</u>	<u>Order-No.</u>	<u>DESCRIPTION</u>	<u>Qty.</u>
2	3310309	Gasket	1
3	3310202	Housing – Left Side	1
4	3310209	Air Flap	1
5	3310203	Motor Fan	1
6	3310208	Bushing	1
7	3310204	Disc	1
8	3310205	Bushing	1
9	3310310	Washer	1
10	3310206	Fan	1
10a	3310311	Ring	1
11	3309088	Clamp	8
12	3310312	Fan Housing	1
13	3310210	Coupling	1
14	3310313	Pump	1
15	1370176	Washer 1/4"	1
16	3300064	Nipple	1
17	3309134	Clamp	2
18	3308075	Oil-Hose	0,7 m
18a	3308075	Oil-Hose	0,65 m
19	3310064	Clamp	1
20	6162436	Fuel Filter	1
21	6163416	Elbow	1
22	3309770	Cable – Solenoid Valve	1
24	1136406	Elbow	1
25	3310314	Plug	1

For repairs use only original spare parts from the manufacturer!

WILMS HW 9120

Exploded view drawing picture 4

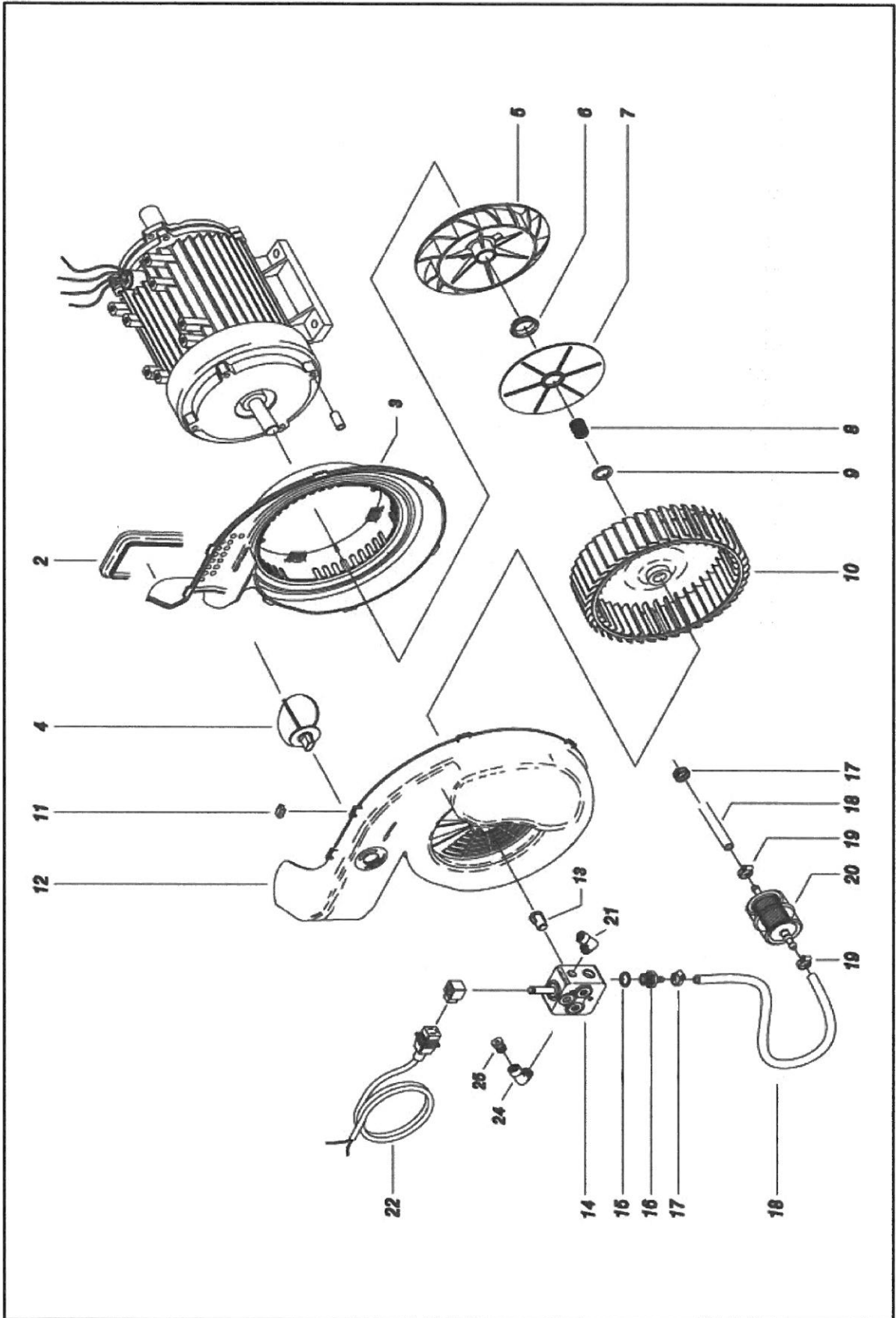

WILMS HW 9120

Spare-Parts List according to drawing 5 (WIRING DIAGRAM)

<u>Pos.</u>	<u>Order-No.</u>	<u>DESCRIPTION</u>	<u>Qty.</u>
C	3310315	Motor Condensor	1
F	3307149	Glass Fuse 1 Amp.	1
K	3310316	Contactora	1
DA	3310070	Switch	1
EC	3310071	Control System	1
EV	3310226	Coil	1
IG	3308222	ON/OFF-Switch	1
PA	3309748	Pump	1
P1	3310318	Pressure Switch	1
P2	3310319	Pressure Switch	1
TA	3310028	Ignition Transformer	1
TH	3309799	Thermostat	1
TR	3310242	Transformer 400/24 V	1
TS	3310075	Thermostat	1
CV1	3310076	Cable	1

For repairs use only original spare parts from the manufacturer!

WILMS HW 9120

Wiring diagram picture 5

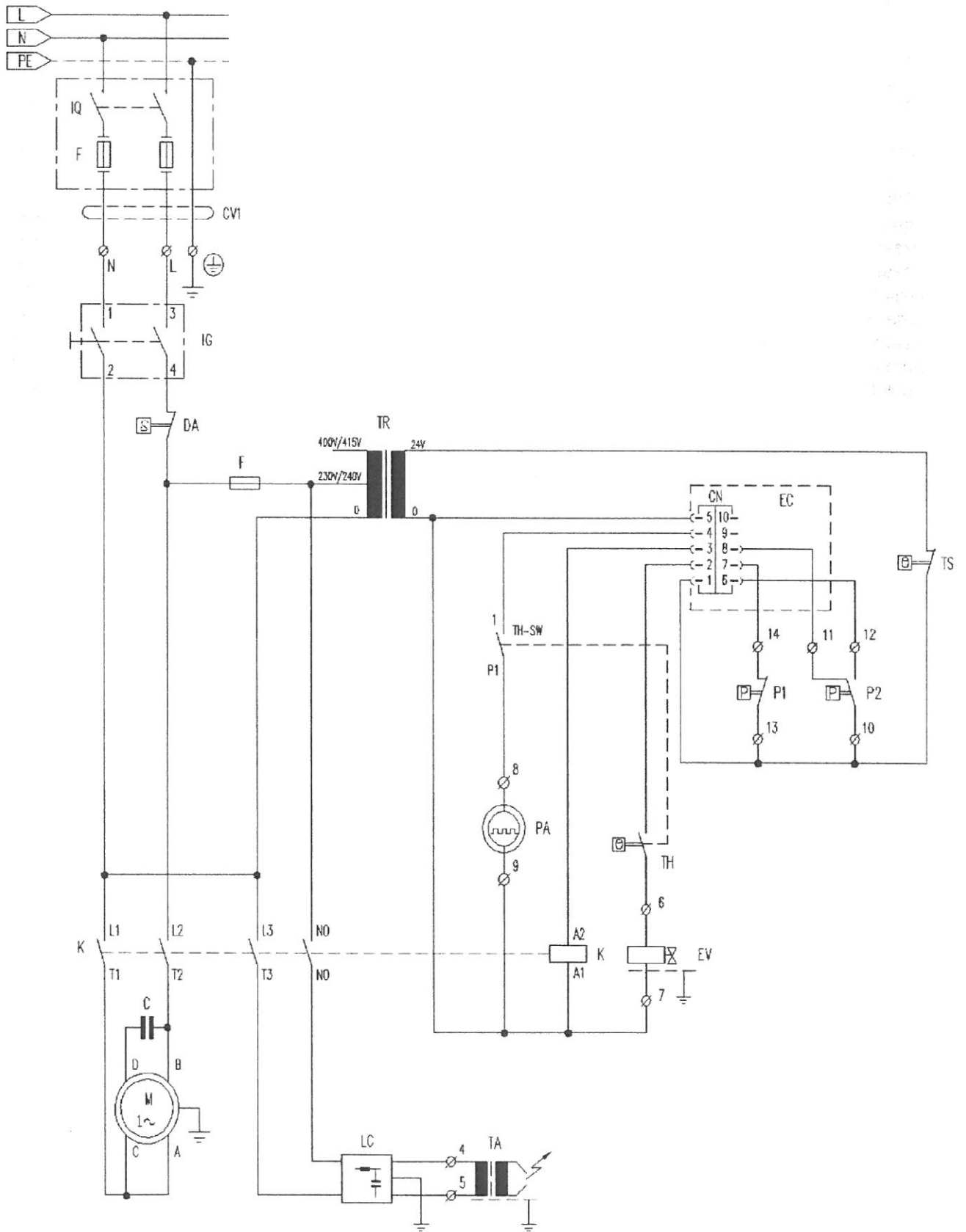

WILMS HW 9120

Exploded view drawing picture 6

<u>Pos.</u>	<u>Order-No.</u>	<u>DESCRIPTION</u>	<u>Qty.</u>
1	1138571	Pump Housing	1
2	1133256	Plug	2
3	1133190	O-Ring	1
4	1133505	Protection Cap	1
5	1138123	Ring	3
6	1133243	Screw	1
7	1133506	Pump Head	1
8	1133334	Washer	12
9	1138119	Screw	8
15	1133208	O-Ring	7
16	3310138	Locking Screw	5
17	1138742	Valve Complete	6
18	1133509	Ring	3
19	1133510	Sleeve	3
20	1133511	Ring	3
21	1138110	O-Ring	3
22	3309109	O-Ring	3
23	1133227	Oil Inspection Glass	1
24	1138050	Roller Bearing Complete	1
25	1133323	Oil Tip Rod	1
26	1138052	Nut	3
27	1138053	Washer	3
28	1133513	Piston	3
29	3300108	O-Ring	3
30	1138055	Protection Ring	3
31	1138056	Washer	3
32	1138062	Pin	3
33	1138058	Cover	1
34	1138060	Screw	4
35	3311081	Gasket	1
36	1133291	Connecting Rod	3
37	1138057	Piston Guide	3
38	1133350	Distance Piece	1
39	1133320	O-Ring	1
40	1133514	Gasket Ring	1

For repairs use only original spare parts from the manufacturer!

WILMS HW 9120
Exploded view drawing picture 6

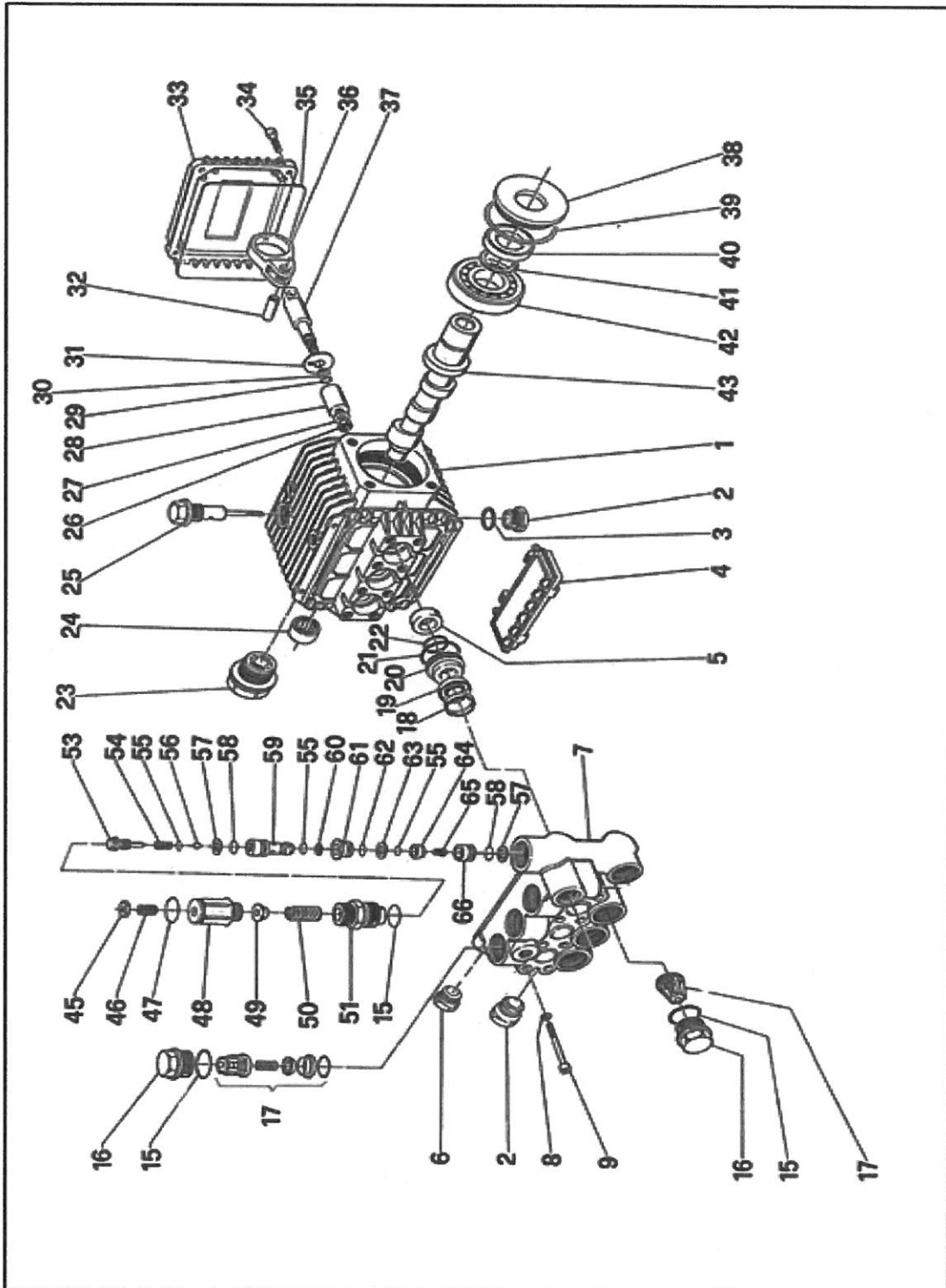

WILMS HW 9120

Exploded view drawing picture 6

<u>Pos.</u>	<u>Order-No.</u>	<u>DESCRIPTION</u>	<u>Qty.</u>
41	1133515	Ring	1
42	1133516	Ball Bearing	1
43	1133517	Crank Shaft	1
45	1138052	Nut	1
46	1138351	Screw	1
47	3300122	O-Ring	1
48	1138352	Adjusting Screw	2
49	1138353	Spring Plate	1
50	1138354	Spring	11
51	1138355	Bushing Guide	1
53	1138356	Guide	1
54	1138357	Spring	1
55	1138358	O-Ring	3
56	1138359	Ball	1
57	1138360	Support Ring	2
58	1138177	O-Ring	2
59	1138361	Control Piston	1
60	1138362	Protection Ring	2
61	1138363	Valve Guide	2
62	1138364	O-Ring	1
63	1138365	Ring	1
64	1138366	Valve	1
65	1138367	Screw	1
66	1138368	Valve Seat	1
	1133294	Kit No. 83 consisting of 3 x item 5	1
	1138944	Kit No. 15-123 consisting of 6 x item 17	1
	1133530	Kit No. 15-139 consisting of 3 x item 20,21,22	1
	1133531	Kit No. 15-140 consisting of 1 x item 18,19,20,21,22	3
	1133532	Kit No. 15-141 consisting of 3 x item 18,19,21,22	1
	1138370	Kit No. 102 consisting of item 51-66	1

For repairs use only original spare parts from the manufacturer!

WILMS HW 9120

Exploded view drawing picture 6

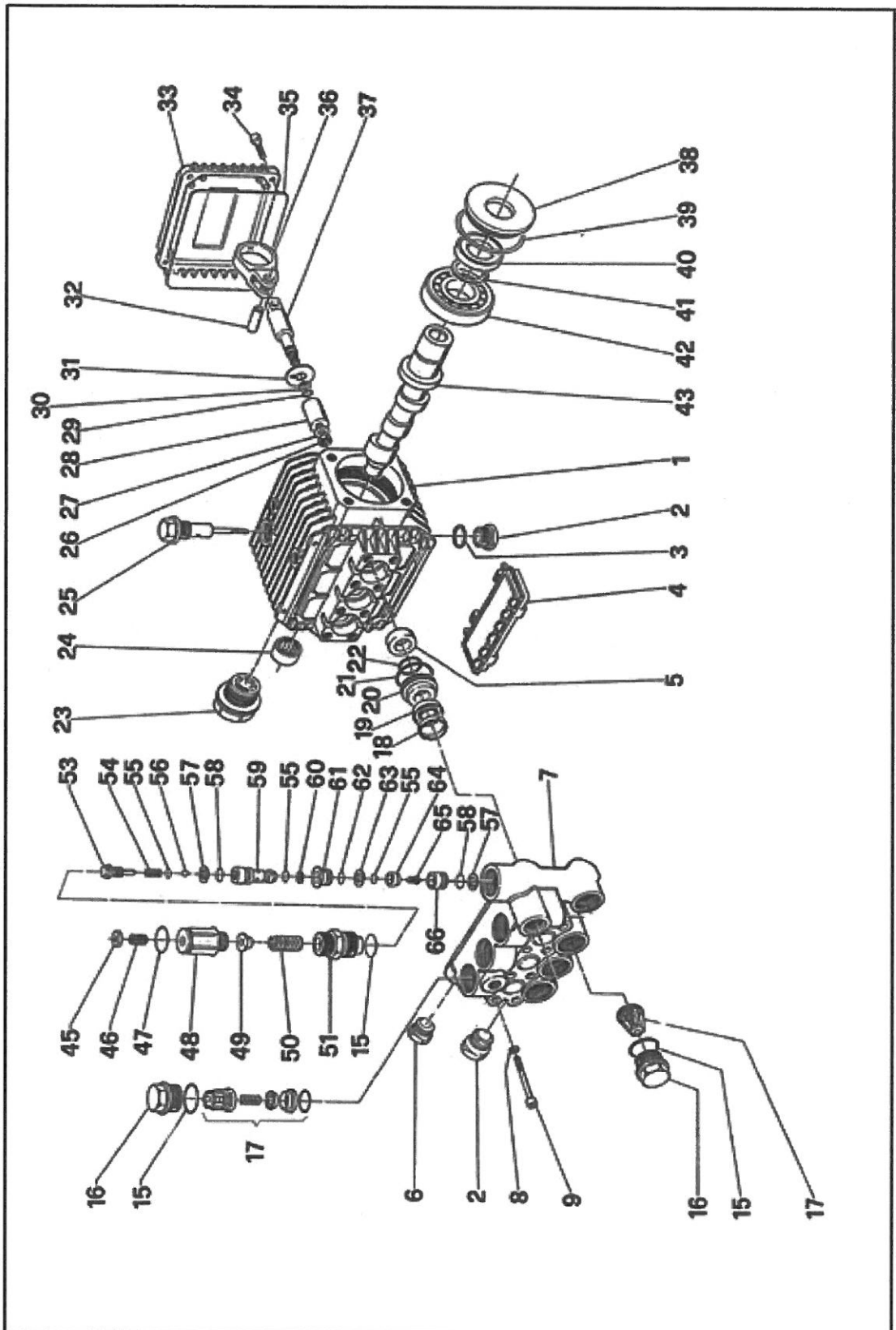

WILMS HW 9120

Exploded view drawing picture 7

<u>Pos.</u>	<u>Order-No.</u>	<u>DESCRIPTION</u>	<u>Qty.</u>
1	1136237	Gun Body	1
2	1136238	Support Ring	1
3	1136239	O-Ring	1
4	1136240	Piston Guide	1
5	1136530	Seat	1
6	1136531	Ball	1
7	1136532	Spring	1
8	1136244	O-Ring	1
9	1136245	Bushing	1
10	1136246	Gasket	4
11	1136247	Pipe	1
12	1136248	Bushing	1
13	1136534	Nut	1
14	1136250	Bushing	1
15	1136251	Guard Ring	1
16	1136252	Ring	1
17	1136253	O-Ring	1
18	1136254	Nipple	1
19	1136257	Pin	2
20	1136347	Leverage	1
21	1136348	Lockable Leverage	1
22	1136349	Housing Right	1
23	1136536	Cover	1
24	1136537	Piston	1
25	1136258	Spring	1
26	1136351	Housing Left	1
27	1136352	Cover	1
28	1136261	Screw	12
29	1136538	Tube	1
30	1136265	Bushing	1
31	1136266	Contactora	1
35	1136271	Pin	1
36	1136270	Clamp	1
37	1136267	Nut	1
38	1138575	Nipple	1
39	1138574	Guard Ring	1
40	331037	O-Ring	1
	1136273	Kit No. 26 consisting of item 15,16,17	1
	1136541	Kit No. 26-36 consisting of item 2,3,5,6	1

For repairs use only original spare parts from the manufacturer!

WILMS HW 9120

Exploded view drawing picture 7

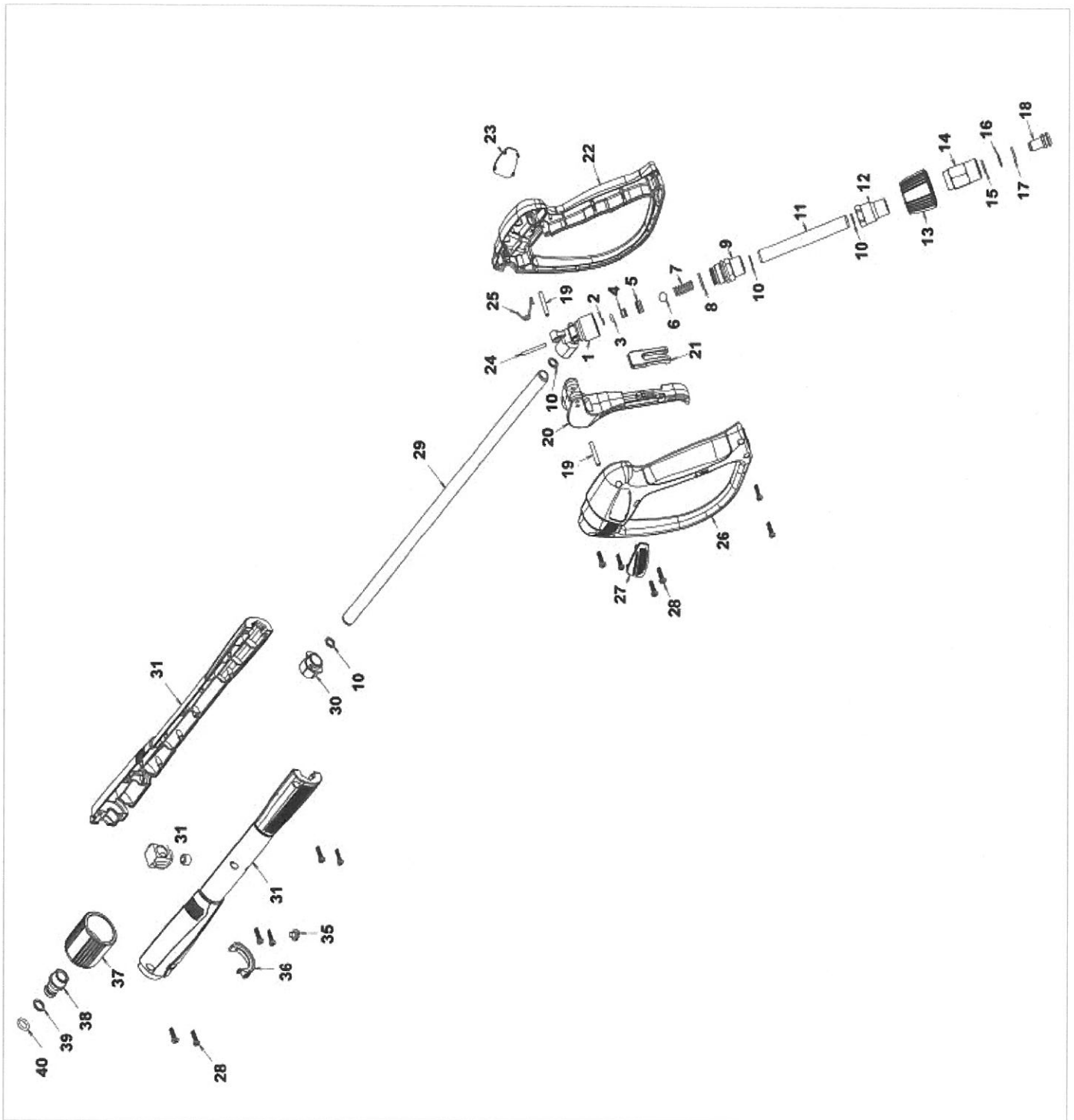

WILMS HW 9120

Exploded view drawing picture 8

<u>Pos.</u>	<u>Order-No.</u>	<u>DESCRIPTION</u>	<u>Qty.</u>
1	3310080	Nipple	1
2	3308079	O-Ring	1
3	3310081	Seat	1
4	3310082	Spring	1
5	3310083	Ball	1

For repairs use only original spare parts from the manufacturer!

